

SPECIFICATIONS FOR BLINKING LED LAMPS

LFI80060

WENRUN OPTOELECTRONIC

Features:

- Operating voltage rang: 3V~8V DC
- Applications for decoration light
- Low power consumption.
- With built-in blinking IC.
- Blinking frequency from 2.0Hz to 2.8Hz.
- This product doesn't contain restriction Substance, comply ROHS standard.

Selection Guide:

Part No.	Chip		Lens Type
	Material	Emitting Color	
LFI80060	GaAsP	Orange	Red Diffused

Package Dimensions:

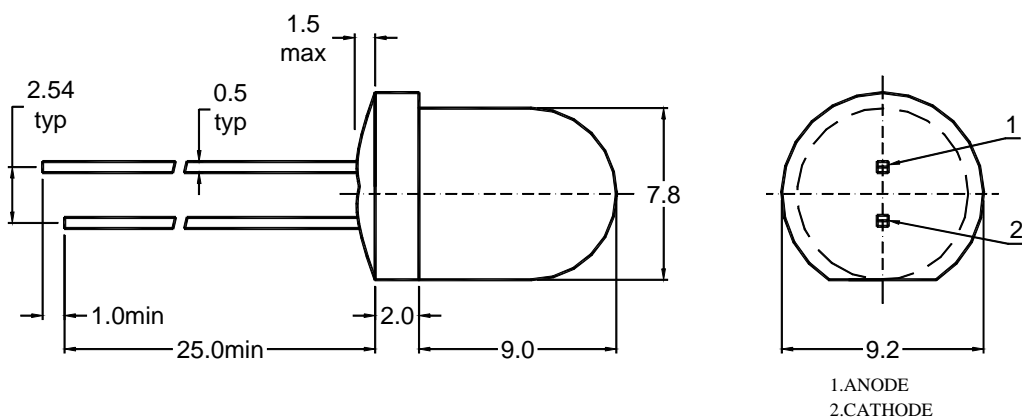

NOTES :

- 1、 All dimensions are in millimetres (mm).
- 2、 Tolerance is $\pm 0.25\text{mm}(0.01\text{'})$ unless otherwise noted.
- 3、 Protruded resin under flange is 1.5mm Max LED.

Absolute Maximum Rating (Ta=25)

Parameter	Symbol	Max	Unit
Power Dissipation	P_M	150	mW
DC Forward Current	I_F	35	mA
DC Voltage	V_F	8	V
Operating Temperature Range	Topr	-30 ~ +85	
Storage Temperature Range	Tstg	-40 ~ +100	
Soldering Temperature	Tsol	260 ± 5	

Notes : Soldering time 5 seconds.

Electrical Optical Characteristics (Ta=25)

Parameter	Symbol	Min.	Typ.	Max.	Unit	Test Condition
Luminous Intensity	I_V	--	4.0	--	mcd	$V_F=5V$
Operating Voltage	V_F	--	5	6	V	----
Output Current	I_F	--	25	--	mA	$V_F=5V$
Pulse Rate	F	--	2.4	2.8	Hz	$V_F=5V$
Peak Emission Wavelength	P	--	635	--	nm	$V_F=5V$
Spectral Line Half Width		--	35	--	nm	$V_F=5V$

Reliability Test Items and Conditions

NO	Test Item	Test Conditions	Duration	Sample	Ac/Re
1	Temperature Cycle	-40 ~ 25 ~ 100 ~ 25 30min 5min 30min 5min	50cycles	100	0/1
2	High Temp. Storage	Ta=100	1000hours	100	0/1
3	Temp.& Humidity Test	Ta=85 RH=85%	1000hours	100	0/1
4	Low Temp. Storage	Ta=-40	1000hours	100	0/1
5	Solder Heat	Tsol=260 ± 5 , 10s	1times	20	0/1

Label Form Specification

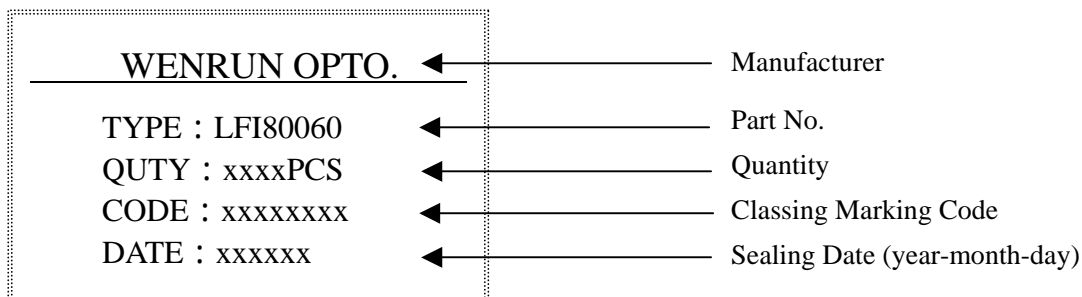

Precautions In Use

A、Soldering Conditions

- 1、 When soldering, leave the minimum clearance between the bottom of the resin and the soldering point.
- 2、 Maximum allowable soldering conditions are.
Solder dipping: 260 max., 5 seconds max., one time.
Soldering iron: 350 max., 5 seconds max., one time.
- 3、 Contact between molten solder and the resin must be avoided.
- 4、 In soldering, do not put any stress on the lead frame, particularly when heated.

B、Lead frame Forming and Use

- 1、 When forming leads ,the leads should be bent at a point at least 3mm from the base of epoxy. Lead forming should be done before soldering.
- 2、 Do not apply any bending stress to the base of the lead. The stress to the base may damage the LEDs characteristics.
- 3、 When mounting the LEDs onto a printed circuit board ,the holes on the circuit board should be exactly aligned with the leads of the LEDs.
- 4、 Please avoid conditions which may cause the LED to corrode, tarnish or discolor. This corrosion or discoloration may cause difficulty during soldering operations. It is recommended that the LEDs be used as soon as possible.
- 5、 Please avoid rapid transitions in ambient temperature, especially, in high humidity environments.

Notes:

- 1、 Above specification may be changed without notice. We will reserve authority on material change for above specification.
- 2、 When using this product, please observe the absolute maximum ratings and the instructions for the specification sheets. We assume no responsibility for any damage resulting from use of the product which does not comply with the instructions included in the specification sheets.