

Specification Sheet

Model name / **SJ9**

Product description / **Street Light**

Revision / **3A**

Issues date / **2013/3/5**

Hergy Lighting Technology Corp.

9F-1 No. 13, Sec.2, Beitou Rd., Beitou Dist., Taipei City 112, Taiwan

TEL: 886-2-28911667

FAX:886-2-28910367

<http://www.hergy.com.tw>



1. Image



2. Specifications

Product number	SJ9 HGS-□□□□7-00D1-09
Input voltage	90 ~ 305 Vac (47~63 Hz)
Power factor	> 0.9
LED brand	CREE / Philips Lumileds
Color temperature	Neutral(4000K) / Cool(5000K)
CRI	75
Luminous output (initial)	7,800 lm
Power consumption	78 W
Luminaires efficacy (initial)	100 lm/W
Light distribution	TYPE I / TYPE II / TYPE III
Dimension	864 x 375 x 174 mm
Weight	10.7 kg
Operating temperature	-40 ~ +50°C
Support dimming function	Optional (1-10V)
Surge protection	10KV/10KA (IEEE/ANSI C62.41.2 complied)
IP protection	IP65
Mounting pole	Outside diameter 60mm & 76mm

- ❖ Luminous flux measurement initial is at 25°C
- ❖ Luminous flux and power consumption measurement allowance is ± 10%
- ❖ CRI allowance is ± 5
- ❖ Dimension allowance is ± 5mm
- ❖ Weight allowance is ± 0.5kg

3. Optical data

TYPE I

Polar graph

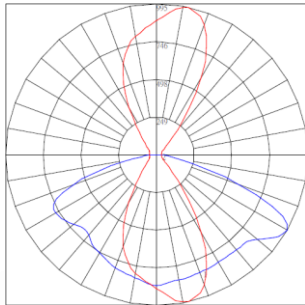

Luminaire classification system graph

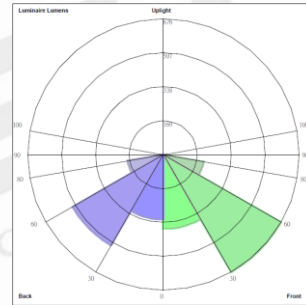

ISO foot candle lines of horizontal illuminance

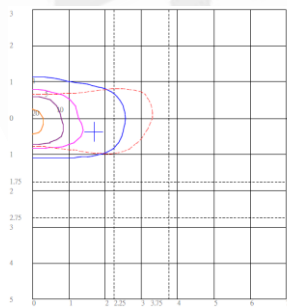

Coefficients of utilization

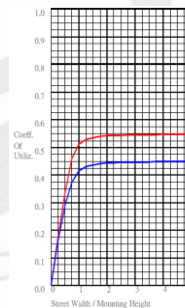

TYPE II (TYPE I tilt 5°)

Polar graph

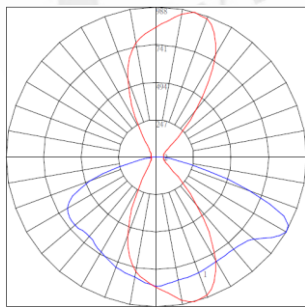

Luminaire classification system graph

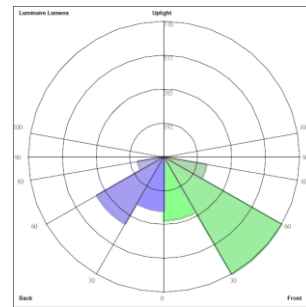

ISO foot candle lines of horizontal illuminance

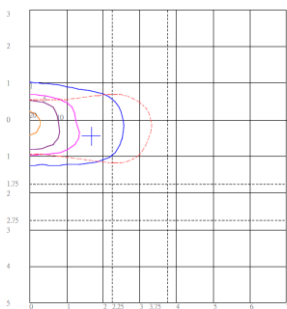

Coefficients of utilization

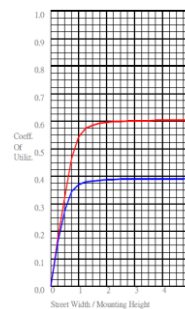

TYPE III

Polar graph

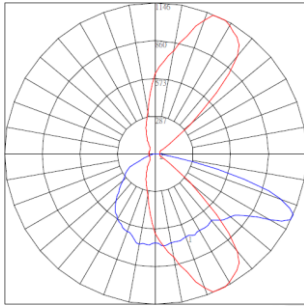

Luminaire classification system graph

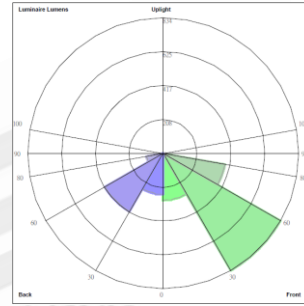

ISO foot candle lines of horizontal illuminance

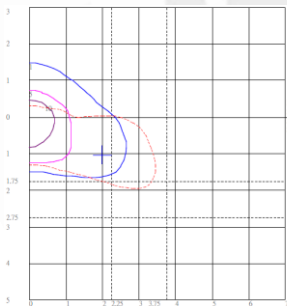

Coefficients of utilization

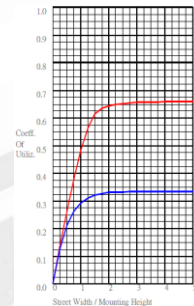

4. Dimension

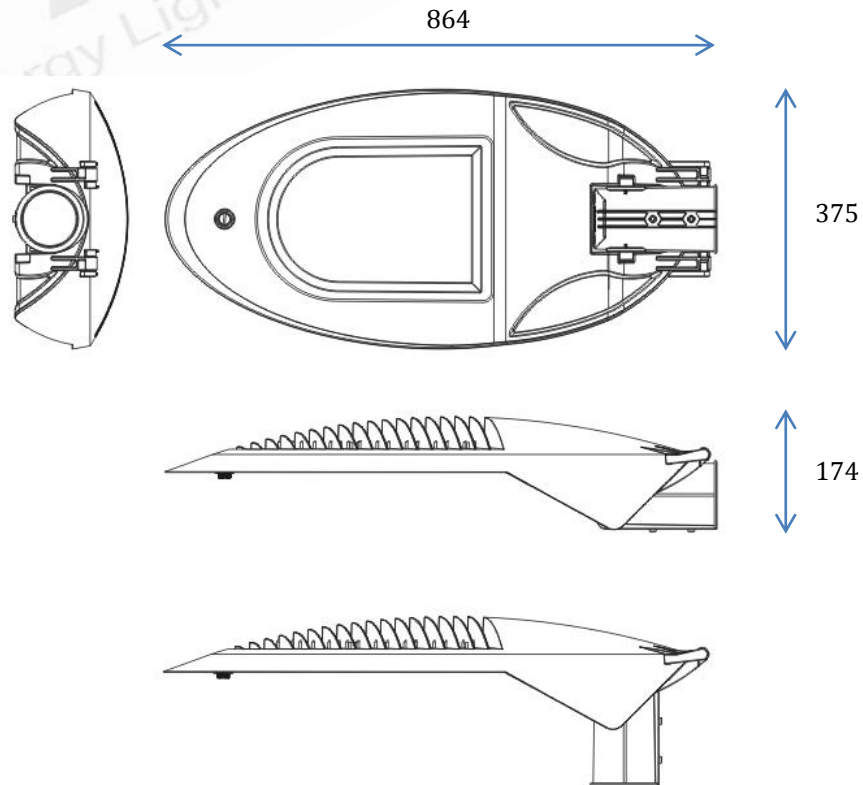

(mm)

5. Packing information

Dimension	988 x 428 x 245 mm
Weight	12.7 kg

6. Attention

1. Always ensure power supply is disconnected before and during installation, maintenance, lamp replacement and accessory fitting.
2. Please ensure the fixture in well grounding.
3. Please prevent to use in sulfide and chloride environment.
4. Do not stare at operating light source directly in 1 meter.
5. Please ensure the wire is connected to the right pole.
[Brown : AC/L ; Blue : AC/N ; Green/Yellow : Grounding]

7. Exemption clause

1. This warranty applies only to the repair or replacement of the product and only when the product is properly handled.
2. This warranty excludes defects resulting from vandalism or unauthorized modification.
3. This warranty excludes defects resulting from improper power supply.
4. This warranty excludes defects resulting from improper wiring.
5. This warranty excludes defects resulting from installation, module replacement with power on.
6. This warranty excludes defects resulting from improper power surges.
7. This warranty excludes defects resulting from acts of God.
8. This warranty excludes defects resulting from special installation like boat or vehicles use (Except specified model).
9. This warranty excludes defects resulting from installation outside set ambient temperature.
10. This warranty excludes defects resulting from corrosive environment (Chloride, Sulfide) installations.
11. This warranty excludes defects resulting from wet location installation without proper waterproof connectors.
12. This warranty excludes defects resulting from underwater usage.
13. This warranty excludes defects resulting from visible steam inside LED module by climate change.

8. Order number rule

XX	X-	X	X	XX	X-	XX	X	X-	XX
Company	Category	LED brand	CCT	Optic	Voltage	Socket	Module current	Control	series
Company				Optic					
HG	Hergy			T1	TYPE I				
Category				T2	TYPE II				
S	Street light			T3	TYPE III				
LED brand				Voltage					
C	CREE			7	100~277 Vac				
L	Philips Lumileds			Socket					
CCT				00	pigtail				
C	Cool white			Module current					
N	Neutral white			D	700mA				
W	Warm white			Control					
				1	Non-dimming				
				V	1-10V dimming				