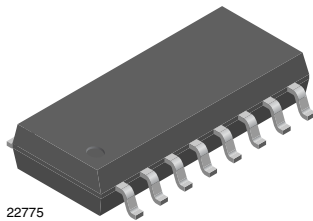
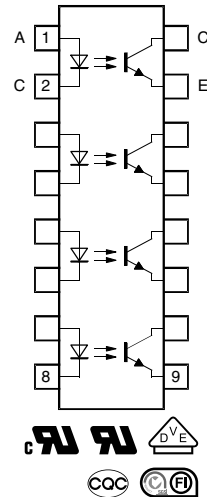


Optocoupler, Phototransistor Output, Quad Channel, Half Pitch Mini-Flat Package



22775



FEATURES

- Low profile package (half pitch)
- AC isolation test voltage 3750 V_{RMS}
- Low coupling capacitance of typical 0.3 pF
- Current transfer ratio (CTR) selected into groups
- Low temperature coefficient of CTR
- Wide ambient temperature range
- Material categorization: for definitions of compliance please see www.vishay.com/doc?99912



APPLICATIONS

- Programmable logic controllers
- Modems
- Answering machines
- General applications

AGENCY APPROVALS

- Safety application model number covering all products in this datasheet is TCMT4100. This model number should be used when consulting safety agency documents.
- UL1577, file no. E76222, double protection
 - cUL, accordance to CSA component acceptance service no. 5A, double protection
 - DIN EN 60747-5-5 (VDE 0884-5)
 - FIMKO EN 60950-1
 - CQC GB4943.1-2011 and GB8898-2011 (suitable for installation altitude below 2000 m)

DESCRIPTION

The TCMT4100 series consist of a phototransistor optically coupled to a gallium arsenide infrared-emitting diode in a 16 pin (quad channel) package.

ORDERING INFORMATION		
<div style="display: flex; justify-content: space-around; align-items: center;"> <div style="border: 1px solid black; padding: 2px 5px;">T</div> <div style="border: 1px solid black; padding: 2px 5px;">C</div> <div style="border: 1px solid black; padding: 2px 5px;">M</div> <div style="border: 1px solid black; padding: 2px 5px;">T</div> <div style="border: 1px solid black; padding: 2px 5px;">4</div> <div style="border: 1px solid black; padding: 2px 5px;">1</div> <div style="border: 1px solid black; padding: 2px 5px;">0</div> <div style="border: 1px solid black; padding: 2px 5px;">#</div> </div> <p style="text-align: center; margin-top: 5px;">PART NUMBER</p>	<p>SSOP-16</p>	
AGENCY CERTIFIED/PACKAGE	CTR (%)	
	5 mA	
UL, cUL, FIMKO, BSI, VDE, CQC	50 to 600	100 to 300
SSOP-16, quad channel	TCMT4100	TCMT4106
SSOP-16, quad channel	TCMT4100T0 ⁽¹⁾	-

Notes

- Available only on tape and reel.
- (1) Product is rotated 180° in tape and reel cavity.



ABSOLUTE MAXIMUM RATINGS ($T_{amb} = 25\text{ }^{\circ}\text{C}$, unless otherwise specified)				
PARAMETER	TEST CONDITION	SYMBOL	VALUE	UNIT
INPUT				
Reverse voltage		V_R	6	V
Forward current		I_F	60	mA
Forward surge current	$t_p \leq 10\text{ }\mu\text{s}$	I_{FSM}	1.5	A
Power dissipation		P_{diss}	100	mW
Junction temperature		T_j	125	$^{\circ}\text{C}$
OUTPUT				
Collector emitter voltage		V_{CEO}	70	V
Emitter collector voltage		V_{ECO}	7	V
Collector current		I_C	50	mA
Collector peak current	$t_p/T = 0.5$, $t_p \leq 10\text{ ms}$	I_{CM}	100	mA
Power dissipation		P_{diss}	150	mW
Junction temperature		T_j	125	$^{\circ}\text{C}$
COUPLER				
AC isolation test voltage (RMS)	Related to standard climate 23/50 DIN 50014	V_{ISO}	3750	V_{RMS}
Total power dissipation per channel		P_{tot}	250	mW
Operating ambient temperature range		T_{amb}	-40 to +100	$^{\circ}\text{C}$
Storage temperature range		T_{stg}	-40 to +125	$^{\circ}\text{C}$
Soldering temperature ⁽¹⁾		T_{sld}	260	$^{\circ}\text{C}$

Notes

- Stresses in excess of the absolute maximum ratings can cause permanent damage to the device. Functional operation of the device is not implied at these or any other conditions in excess of those given in the operational sections of this document. Exposure to absolute maximum ratings for extended periods of the time can adversely affect reliability.
- ⁽¹⁾ Refer to reflow profile for soldering conditions for surface mounted devices. Also refer to "Assembly Instructions" (www.vishay.com/doc?80054).

ELECTRICAL CHARACTERISTICS ($T_{amb} = 25\text{ }^{\circ}\text{C}$, unless otherwise specified)						
PARAMETER	TEST CONDITION	SYMBOL	MIN.	TYP.	MAX.	UNIT
INPUT						
Forward voltage	$I_F = 50\text{ mA}$	V_F	-	1.35	1.6	V
Junction capacitance	$V_R = 0$, $f = 1\text{ MHz}$	C_j	-	8	-	pF
OUTPUT						
Collector emitter voltage	$I_C = 100\text{ }\mu\text{A}$	V_{CEO}	70	-	-	V
Emitter collector voltage	$I_E = 100\text{ }\mu\text{A}$	V_{ECO}	7	-	-	V
Collector dark current	$V_{CE} = 20\text{ V}$, $I_F = 0\text{ A}$	I_{CEO}	-	-	100	nA
COUPLER						
Collector emitter saturation voltage	$I_F = 10\text{ mA}$, $I_C = 1\text{ mA}$	V_{CEsat}	-	-	0.3	V
Cut-off frequency	$V_{CE} = 5\text{ V}$, $I_F = 10\text{ mA}$, $R_L = 100\text{ }\Omega$	f_c	-	100	-	kHz
Coupling capacitance	$f = 1\text{ MHz}$	C_k	-	0.3	-	pF

Note

- Minimum and maximum values are testing requirements. Typical values are characteristics of the device and are the result of engineering evaluation. Typical values are for information only and are not part of the testing requirements.

CURRENT TRANSFER RATIO ($T_{amb} = 25\text{ }^{\circ}\text{C}$, unless otherwise specified)							
PARAMETER	TEST CONDITION	PART	SYMBOL	MIN.	TYP.	MAX.	UNIT
I_C/I_F	$V_{CE} = 5\text{ V}$, $I_F = 5\text{ mA}$	TCMT4100	CTR	50	-	600	%
		TCMT4106	CTR	100	-	300	%

SWITCHING CHARACTERISTICS ($T_{amb} = 25\text{ }^{\circ}\text{C}$, unless otherwise specified)						
PARAMETER	TEST CONDITION	SYMBOL	MIN.	TYP.	MAX.	UNIT
Delay time	$V_S = 5\text{ V}$, $I_C = 2\text{ mA}$, $R_L = 100\text{ }\Omega$, (see figure 1)	t_d	-	4	-	μs
Rise time	$V_S = 5\text{ V}$, $I_C = 2\text{ mA}$, $R_L = 100\text{ }\Omega$, (see figure 1)	t_r	-	5.5	-	μs
Fall time	$V_S = 5\text{ V}$, $I_C = 2\text{ mA}$, $R_L = 100\text{ }\Omega$, (see figure 1)	t_f	-	7.0	-	μs
Storage time	$V_S = 5\text{ V}$, $I_C = 2\text{ mA}$, $R_L = 100\text{ }\Omega$, (see figure 1)	t_s	-	1.5	-	μs
Turn-on time	$V_S = 5\text{ V}$, $I_C = 2\text{ mA}$, $R_L = 100\text{ }\Omega$, (see figure 1)	t_{on}	-	9.5	-	μs
Turn-off time	$V_S = 5\text{ V}$, $I_C = 2\text{ mA}$, $R_L = 100\text{ }\Omega$, (see figure 1)	t_{off}	-	8.5	-	μs
Turn-on time	$V_S = 5\text{ V}$, $I_F = 10\text{ mA}$, $R_L = 1\text{ k}\Omega$, (see figure 2)	t_{on}	-	3	-	μs
Turn-off time	$V_S = 5\text{ V}$, $I_F = 10\text{ mA}$, $R_L = 1\text{ k}\Omega$, (see figure 2)	t_{off}	-	20	-	μs

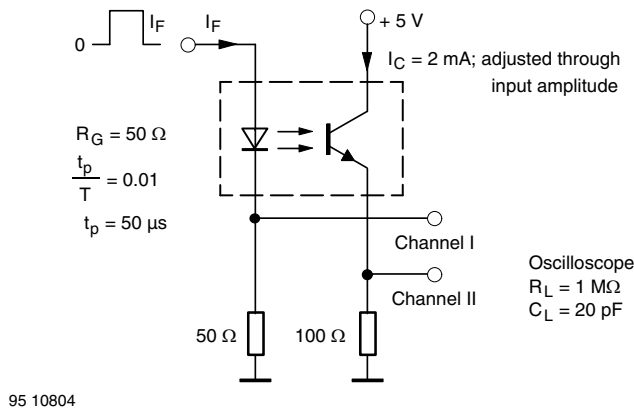


Fig. 1 - Test Circuit, Non-Saturated Operation

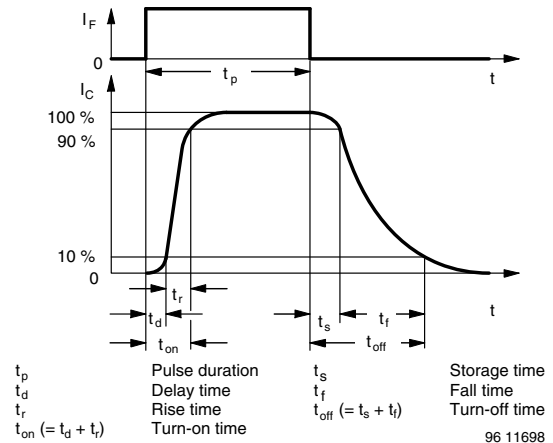


Fig. 3 - Switching Times

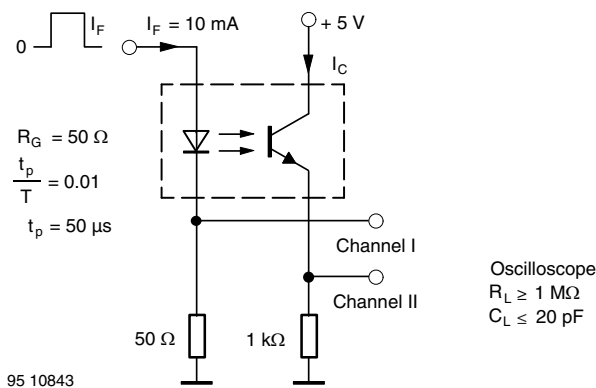


Fig. 2 - Test Circuit, Saturated Operation

SAFETY AND INSULATION RATINGS				
PARAMETER	TEST CONDITION	SYMBOL	VALUE	UNIT
Climatic classification	According to IEC 68 part 1		40 / 110 / 21	
Comparative tracking index		CTI	175	
Maximum rated withstanding isolation voltage	t = 1 min	V _{ISO}	3750	V _{RMS}
Maximum transient isolation voltage		V _{IOTM}	6000	V
Maximum repetitive peak isolation voltage		V _{IORM}	707	V
Apparent charge test voltage (method A)	V _{IORM} × 1.6 = V _{PR} , type and sample test, t _m = 60 s, partial discharge < 5 pC	V _{PR}	1132	V _{peak}
Apparent charge test voltage (method B)	V _{IORM} × 1.875 = V _{PR} , 100 % production test with t _m = 1 s, partial discharge < 5 pC	V _{PR}	1326	V _{peak}
Isolation resistance	V _{IO} = 500 V _{DC} , T _{amb} = 100 °C	R _{IO}	10 ¹¹	Ω
Isolation resistance (under fault conditions)	V _{IO} = 500 V _{DC} , T _{amb} = T _{SI}	R _{IO}	10 ⁹	Ω
Output safety power		P _{SO}	265	mW
Input safety current		I _{SI}	130	mA
Input safety temperature		T _{SI}	150	°C
Creepage distance			≥ 5	mm
Clearance distance			≥ 5	mm
Insulation thickness, reinforced rated	Per IEC 60950 2.10.5.1	DTI	≥ 0.4	mm

Note

- As per IEC 60747-5-5, § 7.4.3.8.2, this optocoupler is suitable for “safe electrical insulation” only within the safety ratings. Compliance with the safety ratings shall be ensured by means of protective circuits.

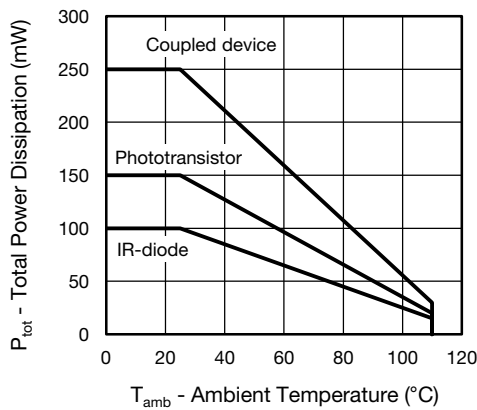
TYPICAL CHARACTERISTICS (T_{amb} = 25 °C, unless otherwise specified)


Fig. 4 - Total Power Dissipation vs. Ambient Temperature

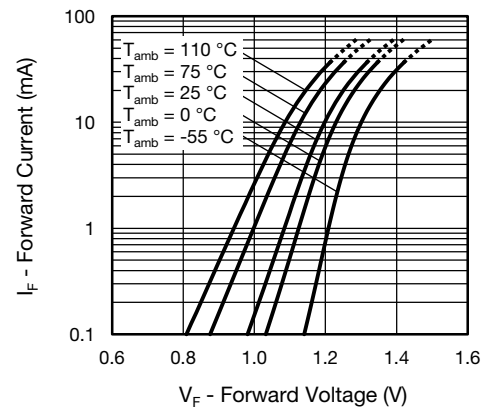


Fig. 5 - Forward Voltage vs. Forward Current

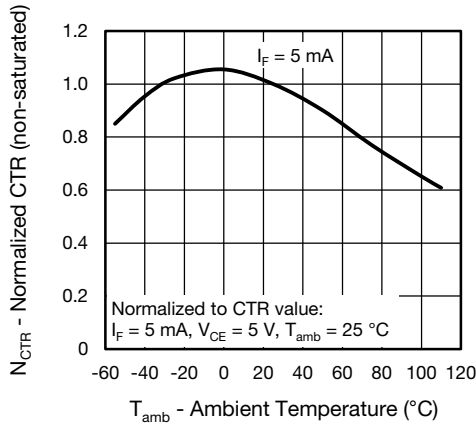


Fig. 6 - Normalized Current Transfer Ratio (non-saturated) vs. Ambient Temperature

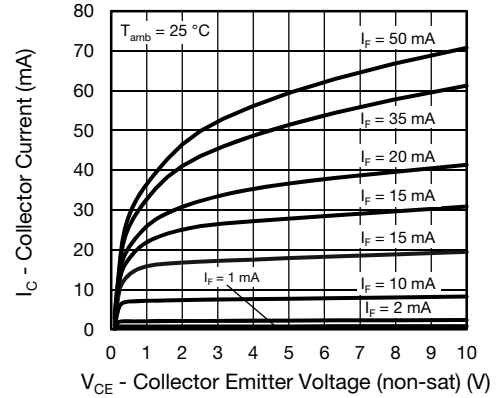


Fig. 9 - Collector Current vs. Collector Emitter Voltage (non-saturated)

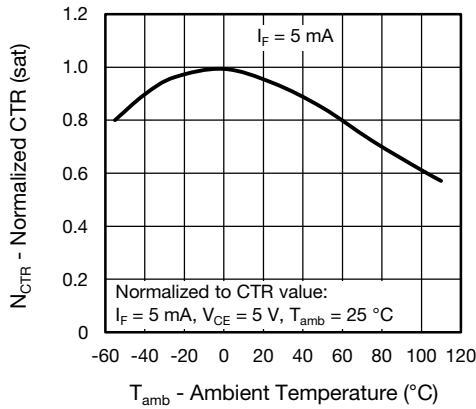


Fig. 7 - Normalized Current Transfer Ratio (saturated) vs. Ambient Temperature

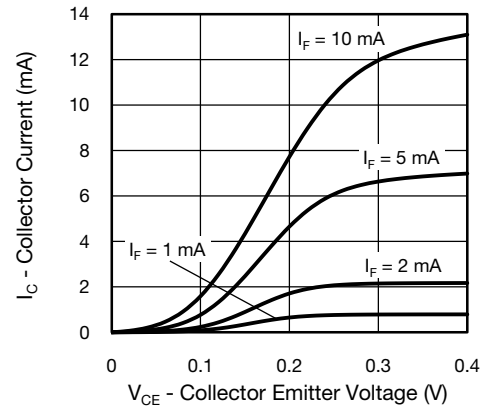


Fig. 10 - Collector Current vs. Collector Emitter Voltage (saturated)

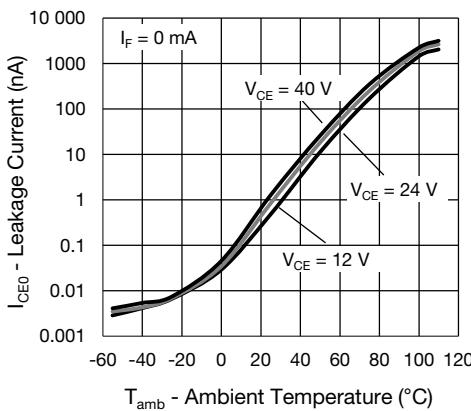


Fig. 8 - Collector Dark Current vs. Ambient Temperature

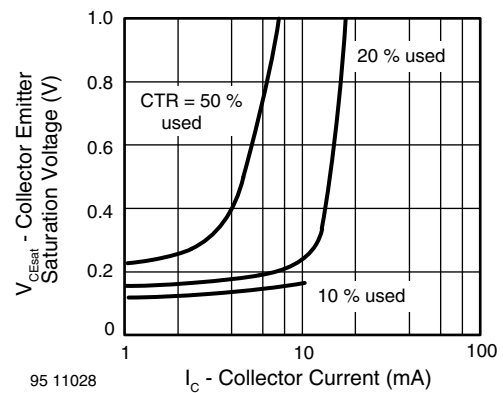


Fig. 11 - Collector Emitter Saturated Voltage vs. Collector Current

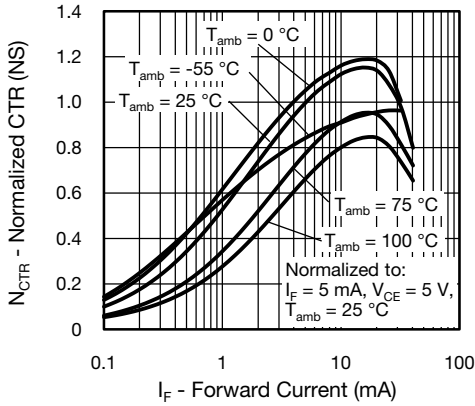


Fig. 12 - Normalized CTR (non-saturated) vs. Forward Current

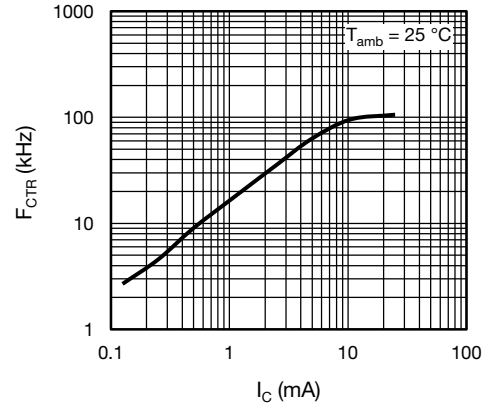


Fig. 15 - F_{CTR} vs. Collector Current

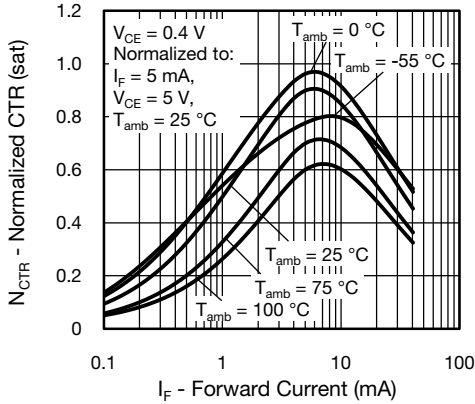


Fig. 13 - Normalized CTR (saturated) vs. Forward Current

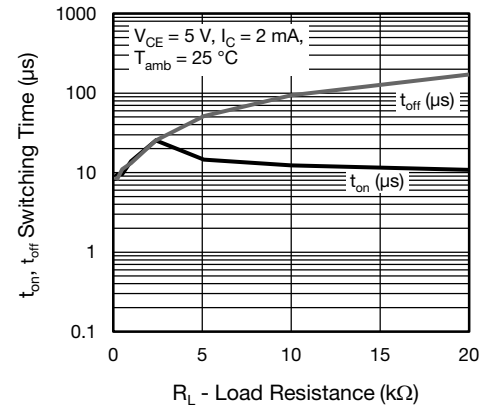


Fig. 16 - Switching Time vs. Load Resistance

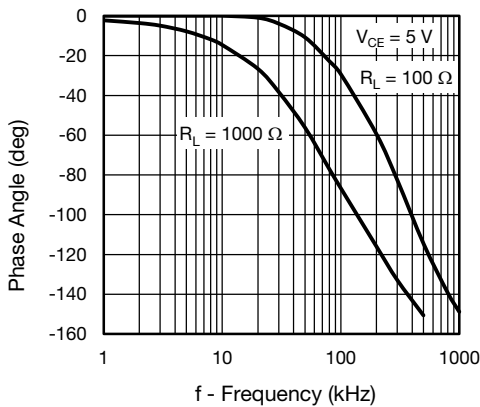


Fig. 14 - Phase Angle vs. Frequency

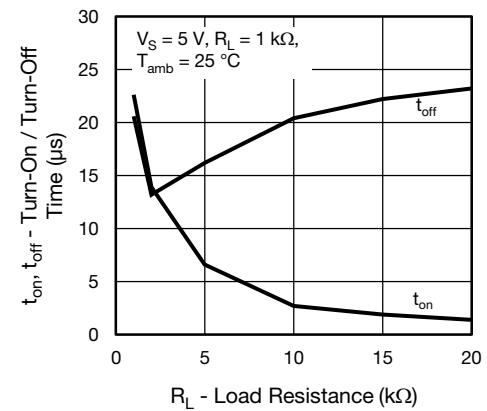


Fig. 17 - Turn-On / Turn-Off Time vs. Load Resistance

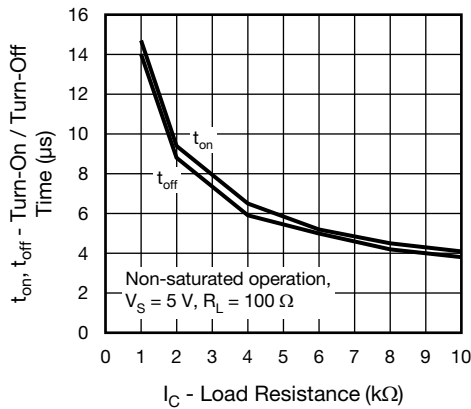
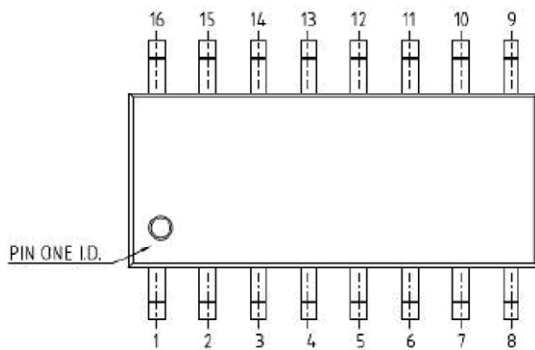
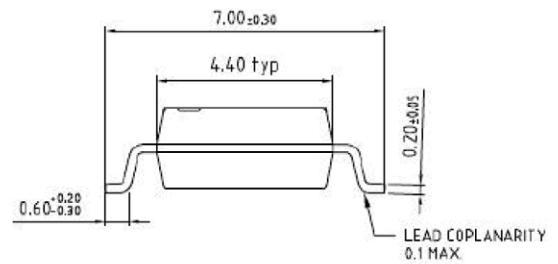
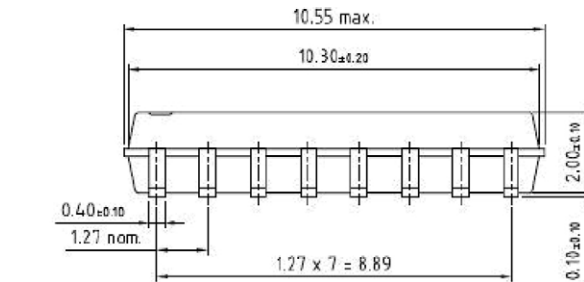
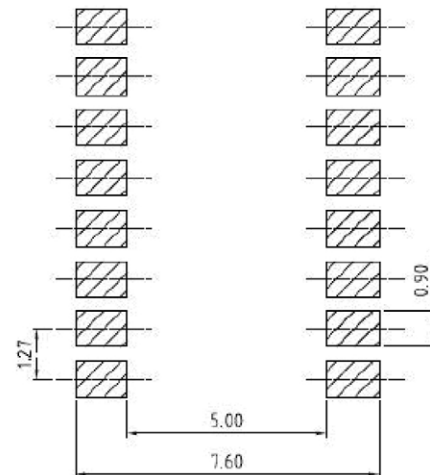


Fig. 18 - Switching Time vs. Load Resistance

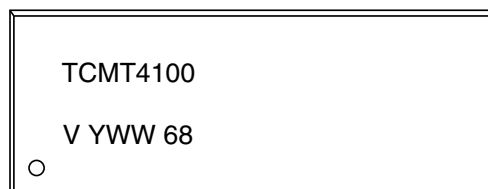
PACKAGE DIMENSIONS (in millimeters)



Possible footprint



PACKAGE MARKING (example)



TAPE AND REEL PACKAGING FOR TCMT410X SERIES (in millimeters)

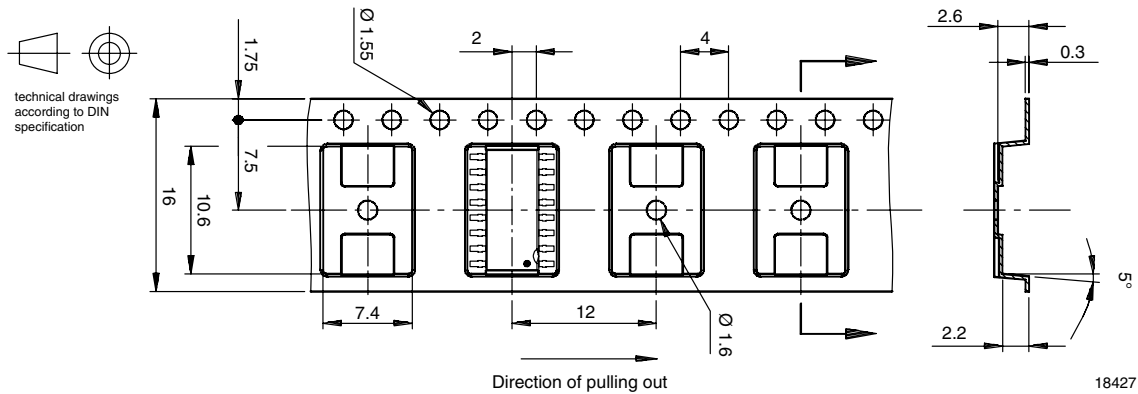


Fig. 19 - 2000 pcs/reel

TAPE AND REEL PACKAGING FOR TCMT410XT0 SERIES (in millimeters)

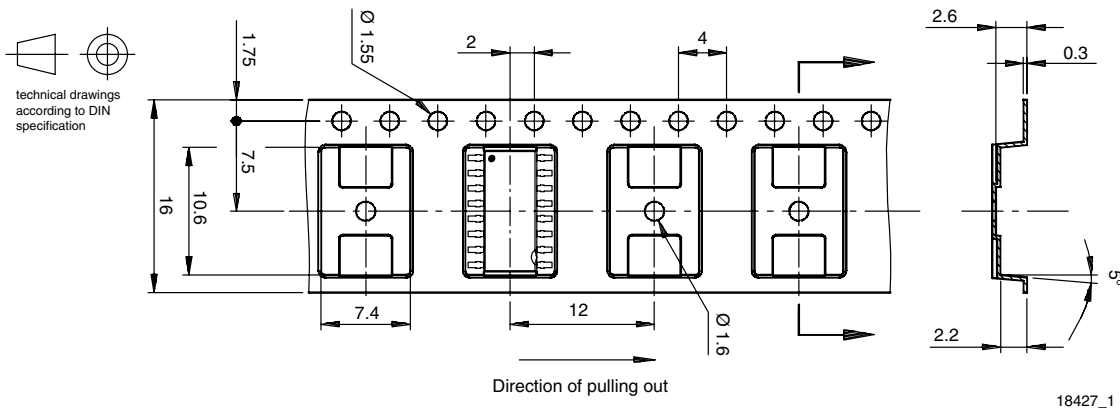


Fig. 20 - 2000 pcs/reel

SOLDER PROFILE

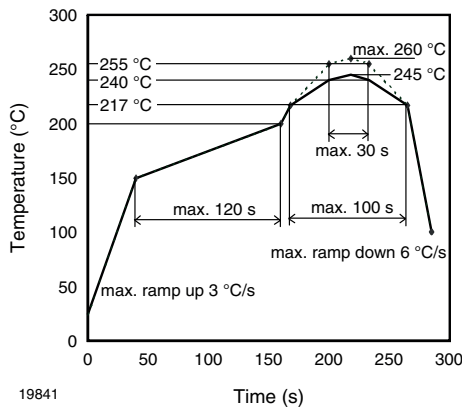


Fig. 21 - Lead (Pb)-free Reflow Solder Profile according to J-STD-020

HANDLING AND STORAGE CONDITIONS

ESD level: HBM class 2

Floor life: unlimited

Conditions: $T_{amb} < 30\text{ }^{\circ}\text{C}$, RH < 85 %

Moisture sensitivity level 1, according to J-STD-020



Disclaimer

ALL PRODUCT, PRODUCT SPECIFICATIONS AND DATA ARE SUBJECT TO CHANGE WITHOUT NOTICE TO IMPROVE RELIABILITY, FUNCTION OR DESIGN OR OTHERWISE.

Vishay Intertechnology, Inc., its affiliates, agents, and employees, and all persons acting on its or their behalf (collectively, "Vishay"), disclaim any and all liability for any errors, inaccuracies or incompleteness contained in any datasheet or in any other disclosure relating to any product.

Vishay makes no warranty, representation or guarantee regarding the suitability of the products for any particular purpose or the continuing production of any product. To the maximum extent permitted by applicable law, Vishay disclaims (i) any and all liability arising out of the application or use of any product, (ii) any and all liability, including without limitation special, consequential or incidental damages, and (iii) any and all implied warranties, including warranties of fitness for particular purpose, non-infringement and merchantability.

Statements regarding the suitability of products for certain types of applications are based on Vishay's knowledge of typical requirements that are often placed on Vishay products in generic applications. Such statements are not binding statements about the suitability of products for a particular application. It is the customer's responsibility to validate that a particular product with the properties described in the product specification is suitable for use in a particular application. Parameters provided in datasheets and / or specifications may vary in different applications and performance may vary over time. All operating parameters, including typical parameters, must be validated for each customer application by the customer's technical experts. Product specifications do not expand or otherwise modify Vishay's terms and conditions of purchase, including but not limited to the warranty expressed therein.

Except as expressly indicated in writing, Vishay products are not designed for use in medical, life-saving, or life-sustaining applications or for any other application in which the failure of the Vishay product could result in personal injury or death. Customers using or selling Vishay products not expressly indicated for use in such applications do so at their own risk. Please contact authorized Vishay personnel to obtain written terms and conditions regarding products designed for such applications.

No license, express or implied, by estoppel or otherwise, to any intellectual property rights is granted by this document or by any conduct of Vishay. Product names and markings noted herein may be trademarks of their respective owners.