

type:	OLBN.FIL.4000K-230mm		
color:	Neutral white	base:	FPC
chip:	InGaN/GaN	Luminous flux:	300 lm
power:	4.0 W	voltage:	260 V
size:	230(length)*1.45(wide) *1.6(deep)mm	current:	IF=15 mA

real photo

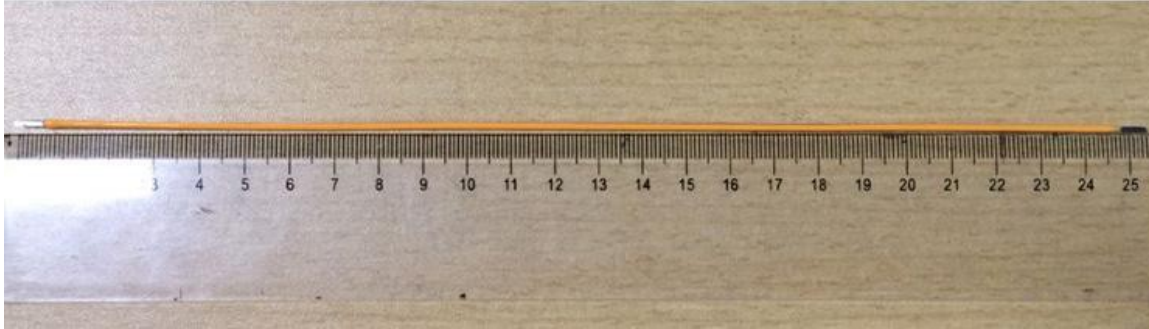

### 1. Product features:

- two sides dispensing, no blue overflow light, 360 degree light;
- soft, 360 degrees turn , bendable
- low power consumption, environmental-friendly, meet environmental standard of ROHS;
- CRI> 90, indoor lighting available.

It can be used for retro bulbs, bulbs, decorative lighting and so on.

### 2. Product size:

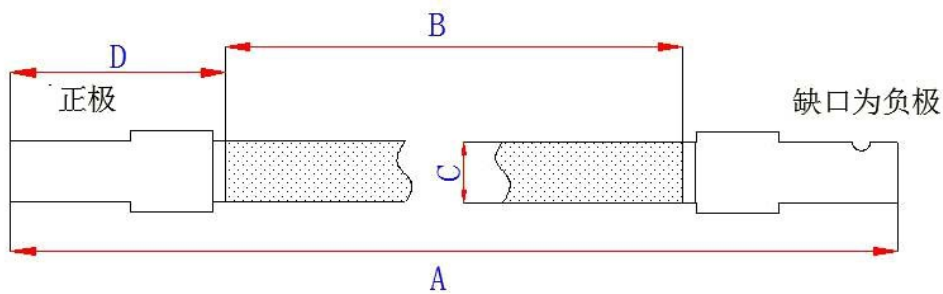

remakes:

A=255mm, errand±1mm; B=230mm, errand±1mm;  
C=1.6mm, errand±0.1mm; D=7mm, errand±0.2mm.

### 3. Naming convention

OLBN.FIL.4000K-230mm

### 4. Maximum rating of the product (Ta=25°C)

parameter	symbol	maximum	unit
Maximum power	PM	4	W
Maximum current	IF	15	mA
Operating temperature range	Topr	-30~85	°C
Storage temperature range	Tstg	-40~100	°C
Junction temperature	Tj	105	°C
Anti static ability	ESD	2000 (HBM)	V

remakes: : It is recommended that the customer not use the maximum rating value, otherwise it will reduce the service life of the product.

## 5. Optical characteristics of products (Ta=25°C)

Color temperature	item	symbol	test condition	minimum value	Typical value	Maximum value	unit
	Forward voltage	VF	IF=15mA	260	263	265	V
	Luminous angle	2 θ 1/2	IF=15mA	-	360	-	Deg
27 (U,N,D)	Luminous flux	Φ	IF=15mA	320	330	--	lm
	Color coordinate	x		-	0.4578	-	-
		y		-	0.4101	-	-
	Correlated color temperature	CCT		4198	3989	4019	K
		Ra		90.1	91.5	-	-
22 (U,N,D)	Luminous flux	Φ	IF=15mA	300	320	--	lm
	Color coordinate	x		-	0.4929	-	-
		y		-	0.4122	-	-
	Correlated color temperature	CCT		4010	4109	3989	K
	CRI	Ra		90	91.5	-	-

remakes:

- 1.luminous flux ±5%.
2. CCT ±80K
3. Forward voltage±1V
- 4.test by HAAS2000

## 6. Package: (200 pcs/box)

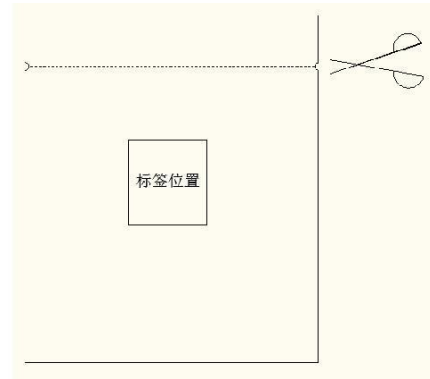
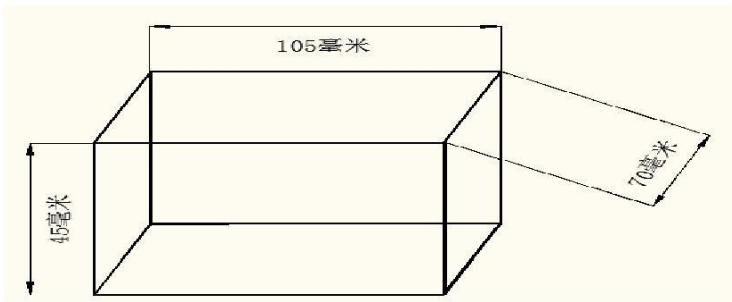

## 7. Typical photoelectric characteristic curve

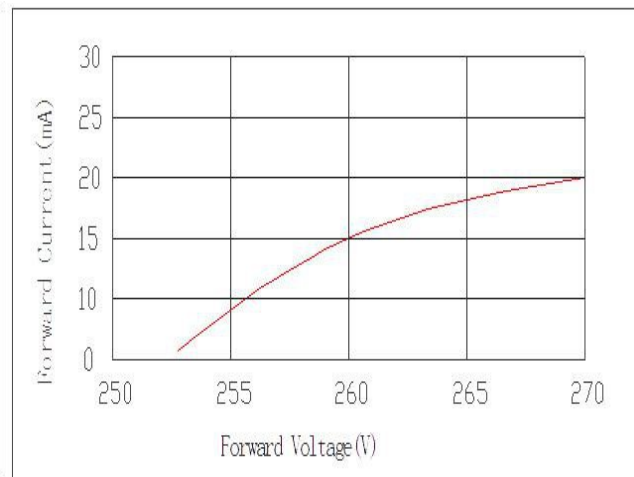
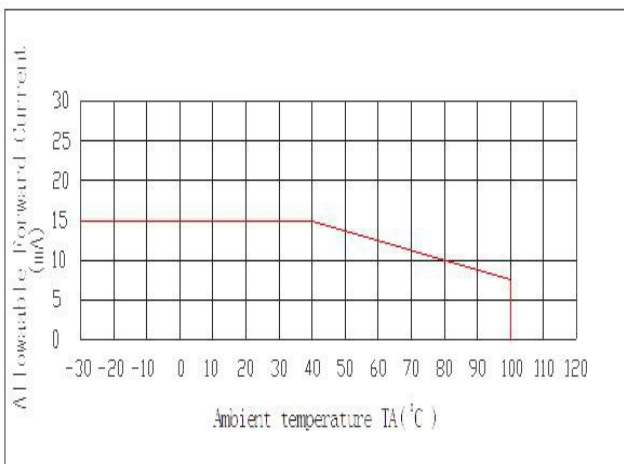
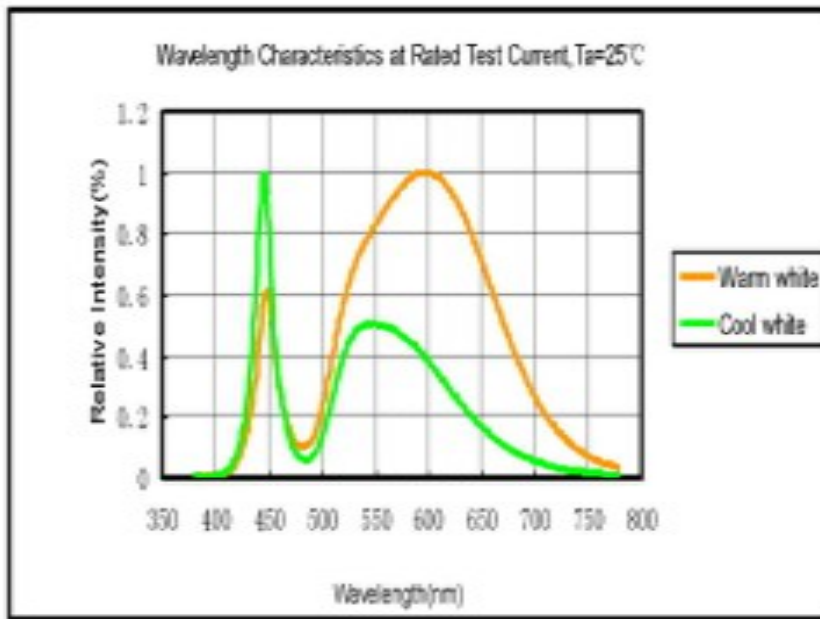

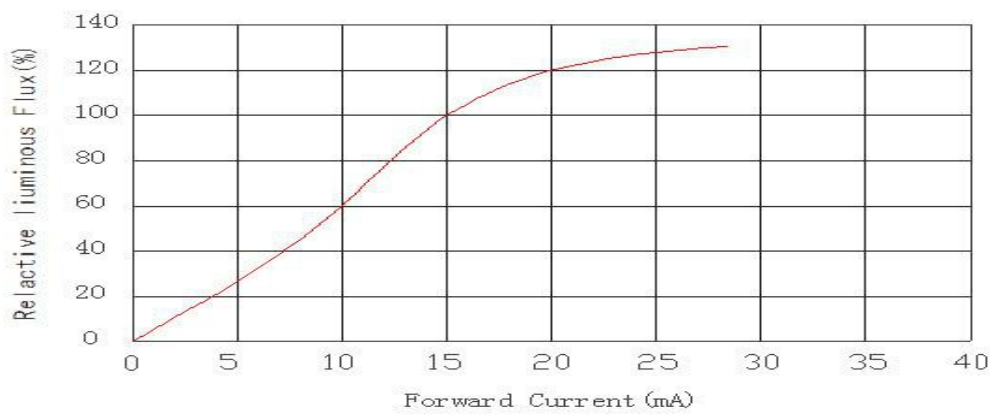

## 8. Production reliability test

### (1) Experiment content and condition

NO.	Text item	Test condition	sample quantity	Ac/Dc
1	temperature cycle	-40°C(30min)~25°C(5min)~100°C(30min),100cycles	10	0/1
2	Thermal Shock	-40°C(30min)~(10S)~100°C(30min),100cycles	10	0/1
3	High temperature and humidity	Tstg=60°C,RH=90%,Time=1000h	10	0/1
4	High temperature storage	Tstg=100°C,Time=1000h	10	0/1
5	Low temperature storage	Tstg=-40°C,Time=1000h	10	0/1
6	Room temperature aging	Tc=25°C,IF=15mA,Time=1000h	10	0/1
7	High temperature aging	Tc=85°C,IF=15mA,Time=1000h	10	0/1

### (2) Invalid judgment standard

item	Symbol	Test condition	Invalid quantity	
			minimum	maximum
Forward voltage	VF	IF=15mA	---	1.1 times the initial voltage
Luminous flux	Φ	IF=15mA	0.8 times the initial brightness	---
appearance	/	Eye-measurement	No mechanical damage	

## 9. Matters need attention

- **Package:**

LED Filament products are encapsulated by Silica gel,  
Silica gel is easy to enter moisture in exposed air.

Heat expansion in high temperature causes product damage,

If the customer opened the package and did not use it within 48 hours, it must be sealed

- **Storage:**

LED soft filament products need to save in 5 ~ 30 degrees, humidity is less than or equal to 60%RH, va cuum packing case, save for a period of 6 months.

- **Application:**

- Try not to mix the products between different batches. The remaining small quantities can be used in combination with the next batch.
- Customers in the welding process can not pull products, in order to avoid bad results.

## 10. Company statement

The use of this product shall be according to the requirements of the specification in order to avoid additional losses.